

液(油)壓缸爆炸 / 剖析圖



爆炸圖型式	適用機型
A 單動/上螺帽/無墊塊型	1. S10 / 20 / 30 / 50 / 100 Series stroke lower than 50mm 2. RSCS10 / 20 / 30 / 50 / 100 Series
A1 單動/上螺帽/墊塊型	RSCS-2503
B 單動/上螺帽/ 溝槽墊塊型	1. S10 / 20 / 30 / 50 / 100 Series stroke higher than 75mm 2. S100 / 150 / 200 Series 3. RSC50 / 75 / 100 Series
C 單動/上螺帽/主軸內牙/ 溝槽(鋼珠)墊塊型	1. RSC5 / 10 / 15 / 25 Series,(except RSC-50)
D 單動/塞底/主軸內牙/ 溝槽(鋼珠)墊塊型	1. RSC 30 tons series
E 超薄RSSM型	1. RSC-50 2. RSSM 5/ 10/ 20/ 30/ 50/ 75/ 100/ 150 tons
F 鋁合金RSAC型	1. RSAC 20/ 30/ 50/ 100/ 150 tons
G 單動中空RSCH型	1. RSCH12 / RSCH306/ RSCH60 / 100 Series
G1 單動中空RSCH型	1. RSCH20 / RSCH30 Series
H 雙動中空RSRH型	1. RSRH 30/ RSRH-1001/ RSRH150 tons
H1 雙動中空RSRH型	1. RSRH-60/ RSRH-1003/ 1006/ 10010
I 雙動/塞底/主軸內牙/ 安全閥-主軸/溝槽墊塊型	1.RSR30 Series
J 雙動/上螺帽/溝槽墊塊型	1.RSR1502/RSR2006
K 雙動/上螺帽/主軸內牙/ 溝槽墊塊型	1.RSR100 Series 2.RSR1506 /15013 /20013 / 3006 / 4006 / 40012 / 5006
K1 雙動/上螺帽/主軸內牙/ 安全閥-主軸/溝槽墊塊型	1.RSR50 / 75 Series
L 雙動/塞底/主軸內牙/ 溝槽墊塊型	1.RSR10 Series
M 雙動/塞底/主軸內牙/ 上螺帽/溝槽墊塊型	1.RSR15032 / RSR20018 / RSR20036 / RSR20048 / RSR30012/ RSR30018 / RSR30036 / RSR30048 / RSR40018 / RSR40024 / RSR40048
M1 雙動/塞底/主軸內牙/ 上螺帽/溝槽墊塊型	1.RSR-20024 / 500 Series,(except RSR5006)
N 單動高噸位CSLS型	1.CSL50 / 100 / 150 / 200 / 250 / 300 / 400 / 500 / S600 / 800 / 1000 Series
O 雙動高噸位CSLRG型	1.CSLRG300 /400 /500 /600 /800 / 1000 / 1600 Series
O1 雙動高噸位CSLRG型	1.CSLRG50 / 100 / 150 / 200 / 250 Series
O2 雙動高噸位CSLRG型	1.CSLRG1000 / CSLRG1600 Series-標準傾斜墊塊
P 單動高噸位CSLSG型	1.CSLSG50 / 100 / 150 / 200 / 250 / 300 /400 / 500 / 800 / 1000 Series
Q 單動高噸位鎖帽CSLL型	1.CSLL50 / 100 / 150 / 200 / 250 / 300 /400 / 500Series
R 單動扁平鎖帽CSLP型	1.CSLP602 / 1002 / 1602 / 2002 / 2502 / 4002 / 5002 Series

爆炸圖型式：C
 單動 / 上螺帽 / 主軸內牙
 / 溝槽(鋼珠)墊塊

適用系列：RSC 5 / 10 / 15 / 25 噸系列
 (RSC-50 除外)



C-單動/上螺帽/主軸內牙/溝槽(鋼珠)墊塊型 (RSC-1512)

項次	品名	數量	品號
1	油壓缸	1	SRC1512-B01
2	主軸	1	SRC1512-B02
* 3	背托環	1	XG40-50-1.9
* 4	O型環	1	XBP040A
5	回縮彈簧組	1	XFP23A-310
* 6	華司	2	XWC13-8-1T
* 7	螺栓	1	XNCAPM08-35
8	上螺帽	1	SRC156-B03
* 9	防塵環	1	XDDS41.4
10	墊塊	1	XKA-SRC-15
11	快速接頭	1	SQB-3/8UF
* 12	螺栓	1	XNCAPM08-35
13	螺牙保護套	1	XCSRC-15

* 代表為修理包

Hydraulic Cylinder Section / Part list Drawing



Drawing Model	Cylinder
A single/ stop ring/ no saddle cylinder	1. S10 / 20 / 30 / 50 / 100 Series stroke lower than 50mm 2. RSCS10 / 20 / 30 / 50 / 100 Series
A1 single/ stop ring/ saddle cylinder	RSCS-2503
B single/ stop ring/ grooved saddle cylinder	1. S10 / 20 / 30 / 50 / 100 Series stroke higher than 75mm 2. S100 / 150 / 200 Series 3. RSC50 / 75 / 100 Series
C single/ stop ring/ plunger threads grooved (snap-in) saddle cylinder	1. RSC5 / 10 / 15 / 25 Series,(except RSC-50)
D single/ base/plunger threads grooved (snap-in) saddle cylinder	1. RSC 30 tons series
E single,Low High, Flat cylinder	1. RSC-50 2. RSSM 5/ 10/ 20/ 30/ 50/ 75/ 100/ 150 tons
F single, Aluminum cylinder	1. RSAC 20/ 30/ 50/ 100/ 150 tons
G single, Hollow plunger cylinder	1. RSCH12 / RSCH306/ RSCH60 / 100 Series
G1 single, Hollow plunger cylinder	1. RSCH20 / RSCH30 Series
H double, Hollow plunger cylinder	1. RSRH 30/ RSRH-1001/ 150 tons
H1 double, Hollow plunger cylinder	1. RSRH-60/ RSRH-1003/ 1006/ 10010
I Double-Acting,Base, Plunger threads,Safety Assembly- plunger,Grooved saddle Cylinders	1.RSR30 Series
J Double-Acting,Stop ring, Grooved saddle Cylinders	1.RSR1502/RSR2006
K Double-Acting,Stop ring, Plunger threads, Grooved saddle Cylinders	1.RSR100 Series 2.RSR1506 /15013 /20013 /3006 /4006 / 40012 / 5006
K1 Double-Acting,Stop ring, Plunger threads, Grooved saddle Cylinders	1.RSR50 /75 Series
L Double-Acting,Base, Plunger threads, Grooved saddle Cylinders	1.RSR10 Series
M Double-Acting,Base,Plunger inner threads, Stop ring,Grooved saddle Cylinders	1.RSR15032 / RSR20018 /RSR20036 / RSR20048/ RSR30012 /RSR30018 / RSR30036/ RSR30048 / RSR40018 / RSR40024 / RSR40048
M1 Double-Acting,Base,Plunger inner threads, Stop ring,Grooved saddle Cylinders	1. RSR-20024 / 500 Series,(except RSR5006)
N Single Acting,High Tonnage Cylinders	1.CSL50 / 100 / 150 / 200 / 250 / 300 / 400 / 500 / S600 / 800 / 1000 Series
O Double-Acting,High Tonnage Cylinders	1.CSLRG300 /400 /500 /600 /800 Series 2.CSLRG1000 / 1600 Series -with grooved saddle
O1 Double-Acting,High Tonnage Cylinders	1.CSLRG50 / 100 / 150 / 200 / 250 Series
O2 Double-Acting,High Tonnage Cylinders	1.CSLRG1000 / CSLRG1600 Series- equipped tilt saddle
P Single Acting,High Tonnage Cylinders	1.CSLSG50 / 100 / 150 / 200 / 250 / 300 /400 / 500 / 800 / 1000 Series
Q Single Acting,High Tonnage,Lock Nut Cylinders	1.CSLL50 / 100 / 150 / 200 / 250 / 300 /400 / 500Series
R Single Acting, Pancake Lock Nut Cylinders	1.CSLP602 / 1002 / 1602 / 2002 / 2502 / 4002 / 5002 Series

Drawing : C
 single / stop ring / plunger threads
 /grooved (snap-in) saddle cylinder

Cylinder : RSC 5/ 10/ 15/ 25 tions
 (except RSC-50)

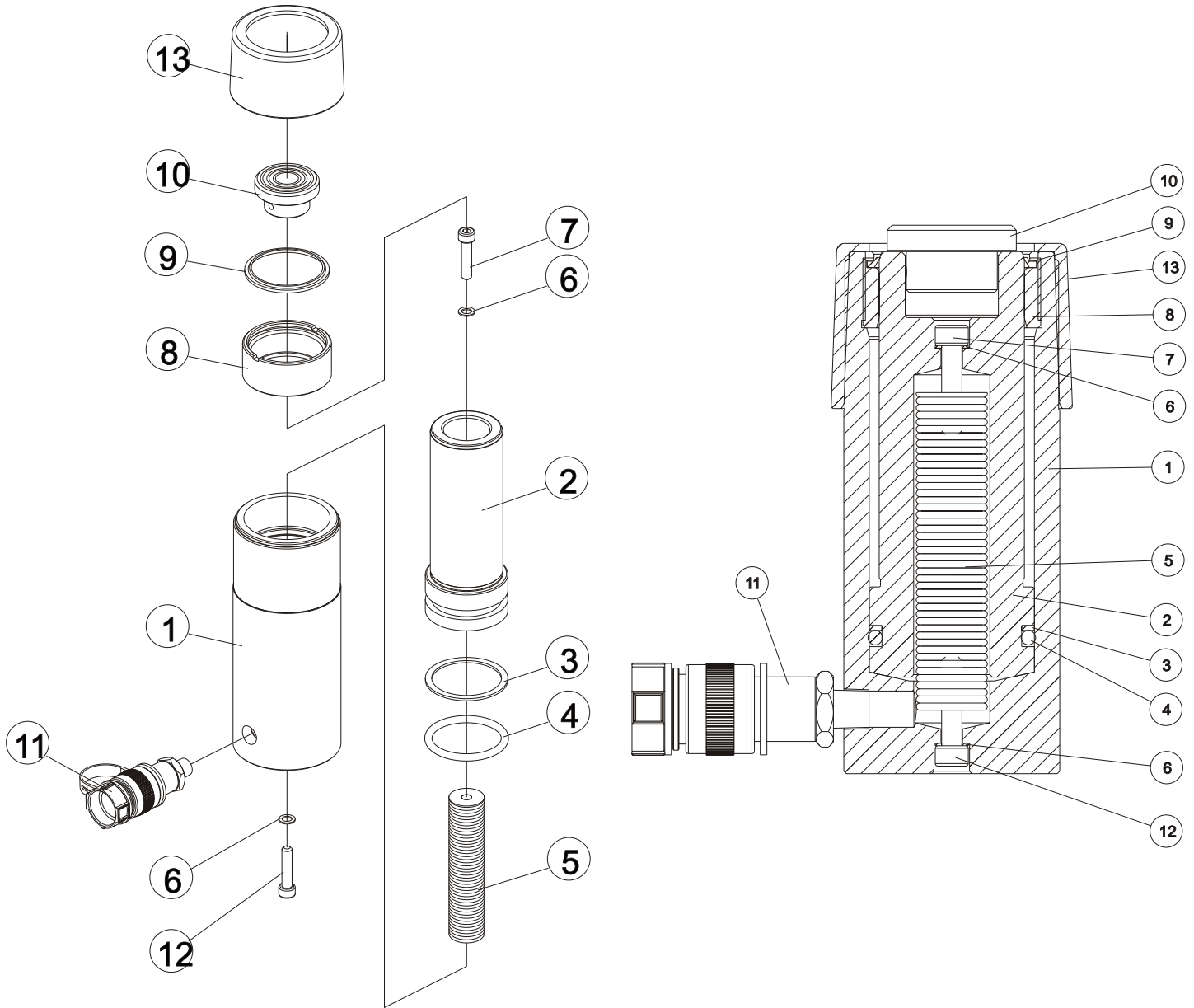

C-Single Acting, Stop ring, Plunger threads,
 Grooved (snap-in) saddle Cylinders (RSC-1512)

Item	Description	Q'ty	Part No.
1	cylinder	1	SRC1512-B01
2	plunger	1	SRC1512-B02
* 3	back-up ring	1	XG40-50-1.9
* 4	o-ring	1	XBP040A
5	spring component	1	XFP23A-310
* 6	cu washer	2	XWC13-8-1T
* 7	bolt	1	XNCAPM08-35
8	stop ring	1	SRC156-B03
* 9	wipers	1	XDDS41.4
10	saddle	1	XKA-SRC-15
11	fast coupler	1	SQB-3/8UF
* 12	bolt	1	XNCAPM08-35
13	thread cover	1	XCSRC-15

*Repair Kit.



Chu Lun sing Co., Ltd.